

**Wolfson**<sup>®</sup>  
*Super Power*



**2023**



**DĂ PUTERE MUNCII TALE**  
**GAMĂ DE PRODUSE**  
**PROFESIONISTE**



### DRUJBE

					
<b>WFS0010</b>	<b>WFS0011</b>	<b>WFS073</b>	<b>DAX2500</b>	<b>DAX6000</b>	<b>WFS0017</b>

PAG. 06 - 09

### DRUJBE

					
<b>WFS0042</b>	<b>WFS0043</b>	<b>WFS0044</b>	<b>WFS0045</b>	<b>WFS0046</b>	<b>WFS0047</b>

PAG. 06 - 09

### DRUJBE

					
<b>WFS0048</b>	<b>WFS0049</b>	<b>WFS0050</b>	<b>WFS0006</b>	<b>WFS0008</b>	<b>WFS080</b>

PAG. 06 - 09

### MOTO COASE

PAG. 10 - 13

### MOTO COASE

					
<b>WFS081</b>	<b>WFS5200A</b>	<b>WFS0009R</b>	<b>WFS0007M</b>	<b>WFS0006.1</b>	<b>WFS076</b>

PAG. 10 - 13

### MAȘINI TUNS GAZON/GARD

PAG. 14

### MAȘINI TUNS GAZON/GARD

					
<b>WFS079</b>	<b>WFS1828R</b>	<b>WFS4100</b>	<b>WFS4600</b>	<b>WFS5100</b>	<b>WFS180SL</b>

PAG. 14

### MAȘINI DE TUNS IARBA

PAG. 15 - 17

### MOTOBURGHIE | SUFLANTE

					
<b>WFS0125</b>	<b>WFS0025</b>	<b>WFS0225</b>	<b>WFS0254B</b>	<b>WFS4000</b>	<b>WFS7000</b>

PAG. 18 - 19

### MOTOSĂPĂTORI

PAG. 20 - 24

## MOTOSĂPĂTORI

					
<b>WFS7000ACC</b>	<b>WFS8000ACC</b>	<b>WFS8001ACC</b>	<b>WFS7000.1</b>	<b>WFS7000.2</b>	<b>WFS7000.3</b>

PAG. 20 - 24

## MOTOSĂPĂTORI

	
<b>WFS7000.4</b>	<b>WFS7000.5</b>

PAG. 20 - 24

## MOTOARE DE UZ GENERAL

	
<b>WFS0026</b>	<b>WFS0027</b>

PAG. 25

## GENERATOARE

	
<b>WFS0029</b>	<b>WFS2000I</b>

PAG. 26 - 30

## GENERATOARE

					
<b>WFS7700D-E</b>	<b>WFS5G19WD</b>	<b>WFS012SS</b>	<b>WFS4650</b>	<b>WFS9250</b>	<b>WFS11050</b>

PAG. 26 - 30

## GENERATOARE

<b>ADG11050</b>

PAG. 26 - 30

## MOTOPOMPE

	
<b>WFS0024</b>	<b>WFS0023</b>

PAG. 31

## MORI

	
<b>WFS0001</b>	<b>WFS0002</b>

PAG. 32

## MORI

<b>WFS0005</b>

PAG. 32

## POMPE DE APĂ

				
<b>WFS0019</b>	<b>WFS0020</b>	<b>WFS0012</b>	<b>WFS0014</b>	<b>WFS0013</b>

PAG. 33 - 40

## POMPE DE APĂ

					
<b>WFS0021</b>	<b>WFS0022</b>	<b>WFS0030</b>	<b>WFS0031</b>	<b>WFS0032</b>	<b>WFS0033</b>

PAG. 33 - 40

### POMPE DE APĂ

 <b>WFS0034</b>	 <b>WFS0035</b>	 <b>WFS0036</b>	 <b>WFS0037</b>	 <b>WFS0038</b>	 <b>WFS0039</b>	<b>PAG. 33 - 40</b>
---	---	---	---	---	---	---------------------

### POMPE DE APĂ

PAG. 33 - 40

 <b>WFS072</b>	<b>SCULE DE MÂNĂ PENTRU GRĂDINĂ</b>				 <b>WFS1280FG</b>	<b>PAG. 41 - 47</b>
	 <b>WFS6036FG</b>	 <b>WFS6036WD</b>	 <b>WFS8038FG</b>	 <b>WFS8038WD</b>		

### SCULE DE MÂNĂ PENTRU GRĂDINĂ

 <b>WFS2790FG</b>	 <b>WFS2080WD</b>	 <b>WFS2032S</b>	 <b>WFS2159P</b>	 <b>WFS2159C</b>	 <b>WFS2159TC</b>	<b>PAG. 41 - 47</b>
--	--	---	---	---	--	---------------------

### SCULE DE MÂNĂ PENTRU GRĂDINĂ

 <b>WFS3077N</b>	 <b>WFS3092T</b>	 <b>WFS2600A3</b>	 <b>WFS0620N</b>	 <b>WFS0620T</b>	 <b>WFS1422T</b>	<b>PAG. 41 - 47</b>
--	--	---	--	--	--	---------------------

### SCULE DE MÂNĂ PENTRU GRĂDINĂ

PAG. 41 - 47

 <b>WFS0300SC</b>	 <b>WFS0180F</b>	<b>FIERĂSTRAIE ELECTRICE</b>		 <b>WFS052</b>	 <b>WFS050</b>	 <b>WFS074</b>	 <b>WFS075</b>	<b>PAG. 48 - 49</b>
---	--	------------------------------	--	--	---	--	--	---------------------

### MIXERE | MAȘINI DE TENCUIT | MAȘINI DE TĂIAT ÎN ZIDĂRIE

PAG. 50

 <b>WFS077</b>	 <b>WFS065</b>	 <b>WFS078</b>	<b>MAȘINI DE ÎNȘURUBAT ȘI GĂURIT CU ACUMULATOR</b>		
			 <b>WFS053</b>	 <b>WFS054</b>	 <b>WFS051</b>



<b>MAȘINI DE GĂURIT ELECTRICE</b>			<b>CIOCANE ROTOPERCUTOARE</b>		<b>POLIZOARE UNGHIULARE</b>
		<b>PAG. 53</b> 		<b>PAG. 54</b> 	<b>PAG. 55</b> 
<b>WFS0034</b>	<b>WFS0035</b>	<b>WFS0036</b>	<b>WFS058</b>	<b>WFS059</b>	<b>WFS0039</b>
<b>POLIZOARE UNGHIULARE   POLIZOARE DE BANC</b>		<b>RINDELE</b>	<b>ȘLEFUITOARE</b>		
	<b>PAG. 55</b> 	<b>PAG. 56</b> 			<b>PAG. 56 - 57</b> 
<b>WFS072</b>	<b>WFS6036FG</b>	<b>WFS066</b>	<b>WFS064</b>	<b>WFS067</b>	<b>WFS068</b>
<b>APARATE DE SUDURĂ</b>		<b>APARATE DE LIPIT ȚEVI</b>		<b>ECHIPAMENTE DE PROTECȚIE</b>	
	<b>PAG. 58</b> 		<b>PAG. 59</b> 		<b>PAG. 60 - 63</b> 
<b>WFS0003</b>	<b>WFS0004</b>	<b>WFS069</b>	<b>WFS070</b>	<b>WFS9001.SB.39</b>	<b>WFS9002.S1P.39</b>
<b>ECHIPAMENTE DE PROTECȚIE</b>					
					<b>PAG. 60 - 63</b> 
<b>WFS9003G</b>	<b>WFS9004VL</b>	<b>WFS9005C</b>	<b>WFS9006VP</b>	<b>WFS9007S</b>	<b>WFS9008PP</b>
<b>ECHIPAMENTE DE PROTECȚIE</b>					
<b>PAG. 60 - 63</b>					
					
<b>WFS9009W</b>					

**DRUJBĂ PROFESIONALĂ WOLFSON® STX-580**

**WFS0010**



**SPECIFICAȚII TEHNICE**

Capacitate cilindrică:	52 cc
Putere:	3.1 CP/ 8500 rpm
Rezervor benzină:	0.55 L
Rezervor ulei:	0.26 L
2buc 16" șină de ghidaj	
2buc 16" lanț	
2buc protecție șină	
1buc bidonaș de mixare	
1buc kit scule	
1buc pâlnie	
1buc mănuși	
1buc ochelari de protecție	

**DRUJBĂ PROFESIONALĂ WOLFSON® STX-620**

**WFS0011**



**SPECIFICAȚII TEHNICE**

Capacitate cilindrică:	58 cc
Putere:	3.5 CP/ 8500 rpm
Rezervor benzină:	0.55 L
Rezervor ulei:	0.26 L
2buc 18" șină de ghidaj	
2buc 18" lanț	
2buc protecție șină	
1buc manual	
1buc bidonaș de mixare	
1buc kit scule	
1buc pâlnie	
1buc mănuși	
1buc ochelari de protecție	
1buc căști antizgomot	



**DRUJBĂ ELECTRICĂ WOLFSON**

**WFS073**



**SPECIFICAȚII TEHNICE**

Putere:	2000W
Tensiune de alimentare:	220V/50Hz
Lamă/Lanț:	14" 3/8 0.05" 44dinți
Viteză lanț:	12 m/s
Bobinaj:	100% cupru
Viteză de rotație:	8000 rpm
Greutate:	5.5 kg

**DRUJBĂ PROFESIONALĂ WOLFSON IMPERIO - 250 - 25CC**

**DAX2500**



**SPECIFICAȚII TEHNICE**

Capacitate cilindrică:	25.4 cc
Putere:	1.3CP/11000 rpm
Lungime lamă:	12"
Lanț:	12" 3/8 0.050" 22dinți
Viteză:	3300±200rpm
Rezervor benzină/ ulei:	230ml/160ml
Accesorii:	lamă, lanț, bidonaș amestec, kit unelte, ochelari de protecție

## DRUJĂ BLADE INDUSTRIAL 600 (WOLFSON IMPERIO) - 52 CC

**DAX6000**



### SPECIFICAȚII TEHNICE

Capacitate cilindrică:	52 cc
Putere:	3.2 CP/8500 rpm
Rezervor benzină:	0.55 L
Rezervor ulei:	0.26 L
1buc 18" șină ghidaj	
1buc 18" lanț	
1buc protecție șină	
1buc bidonaș amestec	
1buc kit unelte	

## DRUJĂ NOUĂ WOLFSON IMPERIO 8500R

**WFS0017**



### SPECIFICAȚII TEHNICE

Capacitate cilindrică:	52 cc
Putere:	3.5 CP/8500 rpm
Rezervor benzină:	0.55 L
Rezervor ulei:	0.26 L
1buc 18" șină ghidaj	
1buc 18" lanț	
1buc protecție șină	
1buc bidonaș amestec	
1buc kit unelte	



**WOLFSON - LAMĂ PENTRU MOTOFIERĂSTRĂU**



Descriere produs	Cod produs
3/25 - 15" - 38 cm - 32 dinti - 64 zale - canal 1.5mm	WFS0042
3/25 - 16 - 40 cm - 33 dinti - 66 zale - canal 1.5mm	WFS0043
3/8 LP - 14 - 35 cm - 25 dinti - 50 zale - canal 1.3mm	WFS0044
3/8 LP - 14 - 35 cm - 26 dinti - 52 zale - canal 1.3mm	WFS0045

**WOLFSON - LANȚ PENTRU MOTOFIERĂSTRĂU**



Descriere produs	Cod produs
3/25 - 32 dinți - 38 cm - (compatibil cu lama WFS0042)	WFS0046
3/25 - 33 dinți - 40 cm - (compatibil cu lama WFS0043)	WFS0047
3/8 Pic - 25 dinți - 35 cm - (compatibil cu lama WFS0044)	WFS0048
3/8 Pic - 26 dinți - 35 cm - (compatibil cu lama WFS0045)	WFS0049

**WOLFSON - SET LAMĂ ȘI LANȚ PENTRU MOTOFIERĂSTRĂU**

**3/25 - 15" - 38 CM - 32 DINȚI  
64 ZALE - CANAL 1.5MM**

**WFS0050**





## MOTOCOASĂ PROFESIONALĂ WOLFSON<sup>®</sup> TRX-620

**WFS0006**

ACCESORII  
**5**  
INCLUSE

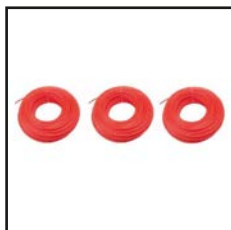

### SPECIFICAȚII TEHNICE

Capacitate cilindrică: 52 cc  
Putere: 3 CP/7500 rpm  
Rezervor benzină: 0.9 L  
Tub aluminiu: 28 mm  
Accesorii: 1buc disc 3T; 1buc cap trimmer;  
3buc 15m fir tăietor; 1buc ham simplu; 1buc  
600ml bidonaș de mixare; 1buc kit unelte

## MOTOCOASĂ PROFESIONALĂ WOLFSON<sup>®</sup> TRX-720

**WFS0008**

ACCESORII  
**12**  
INCLUSE



### SPECIFICAȚII TEHNICE

Capacitate cilindrică: 52 cc  
Putere: 3.5 CP/7500 rpm  
Rezervor benzină: 0.9 L  
Tub aluminiu: 28 mm  
Accesorii: 1buc disc 3T; 1buc disc 9T; 1buc disc  
40T; 1buc cap trimmer; 3buc 15m fir tăietor; 1buc  
ham dublu cu desfacere rapida; 1buc mănuși;  
1buc ochelari; 1buc vizieră protecție; 1buc căști  
protecție; 1buc 600ml bidonaș mixare



**MOTOCOASĂ CU PORNIRE ELECTRICĂ WOLFSON IMPERIO**

**WFS080**



**SPECIFICAȚII TEHNICE**

Capacitate cilindrică:	52 cc
Tip motor:	termic 2T
Putere:	3 CP
Viteză de rotație:	7500rpm
Rezervor benzină:	1.2 L
Diametru tijă:	28 mm
Accesorii:	1buc disc 3T; 1buc disc 40T; 1buc cap trimmer; 1buc 15m fir tăietor; 1buc ham dublu; 1buc 600ml bidonaș de mixare; 1buc kit unelte

**MOTOCOASĂ 4T WOLFSON IMPERIO**

**WFS081**

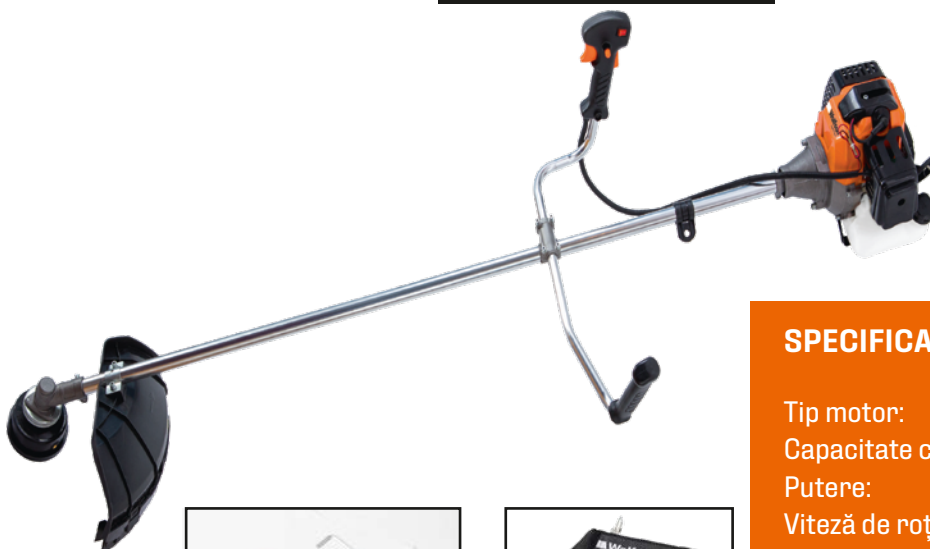

**SPECIFICAȚII TEHNICE**

Tip motor:	Termic, 4T
Capacitate cilindrică:	31 cc
Putere:	1 Cp
Viteză de rotație:	7500 rpm
Rezervor ulei:	0.2 L
Rezervor benzină:	1.2 L
Diametru tijă:	28 mm
Accesorii:	1buc mosor cu fir nylon; 1buc cuțit 3T; 1buc ham

**MOTOCOASA CU ANTI-VIBRAȚII BLADE INDUSTRIAL 520 (WOLFSON IMPERIO)**

**WFS5200A**



**SPECIFICAȚII TEHNICE**

Capacitate cilindrică:	52 cc
Putere:	3 CP/ 7500 rpm
Rezervor benzină:	0.9 L
Tub aluminiu:	28 mm
Sistem anti-vibrații	
Accesorii:	1buc disc 3T; 1buc cap trimmer; 1buc 15m fir tăietor; 1buc ham dublu; 1buc 600ml bidonaș de mixare; 1buc kit unelte; 1buc mănuși

**MOTOCOASĂ CU ROȚI WOLFSON 2CP**

**WFS0009R**



**SPECIFICAȚII TEHNICE**

Capacitate cilindrică:	52 cc
Putere:	3 CP/ 7500 rpm
Rezervor benzină:	0.9 L
Tub aluminiu:	28 mm
Sistem roți de transport	
Accesorii:	1buc Disc 3T; 1buc Cap trimmer ; 1buc 15m fir tăietor; 1buc 600ml bidonaș de mixare; 1buc Kit unelte.



**WOLFSON - UNEALTĂ MULTIFUNCȚIONALĂ 3CP**

**WFS0007M**



**SPECIFICAȚII TEHNICE**

Capacitate cilindrică:	52cc
Putere:	3CP/7500rpm
Rezervor benzină:	0.9L
Tub aluminiu:	28mm
Sistem montare accesorii	
Accesorii:	1buc tijă cu trimmer gard viu; 1buc tijă cu mini drujbă; 1buc tijă montare cositoare; 1buc disc 3T; 1 buc bobină fir; 1 bucată tijă prelungire; 1buc Kit unelte.

**HAM DUBLU WOLFSON® SUPER COMFORT**

**WFS0006.1**





**MAȘINĂ DE TUNS IARBA/GARD VIU CU TIJĂ, BATERIE WOLFSON**

**WFS076**

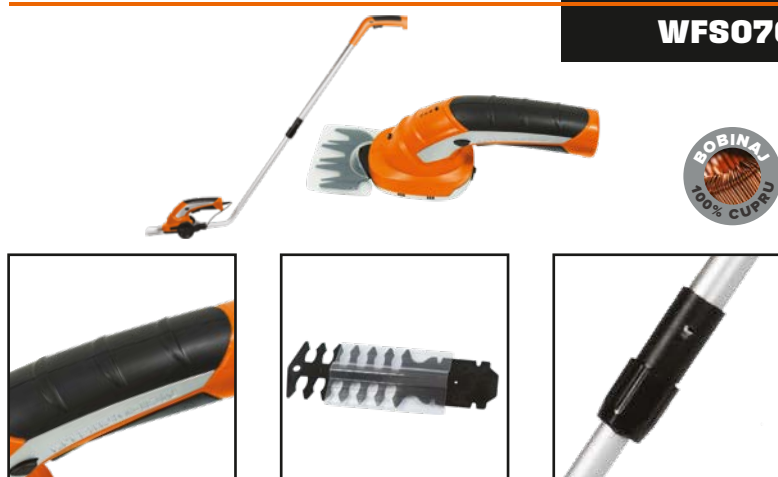

**SPECIFICAȚII TEHNICE**

Tip motor:	Electric
Acumulator:	7.2V 1.5Ah
Dimensiune lamă gazon:	100 X 20mm
Viteză:	1100 rpm
Dimensiune lamă gard viu:	L = 170mm
Grosime max:	8mm
Tijă reglabilă	

**TRIMER IARBĂ 250W WOLFSON**

**WFS079**

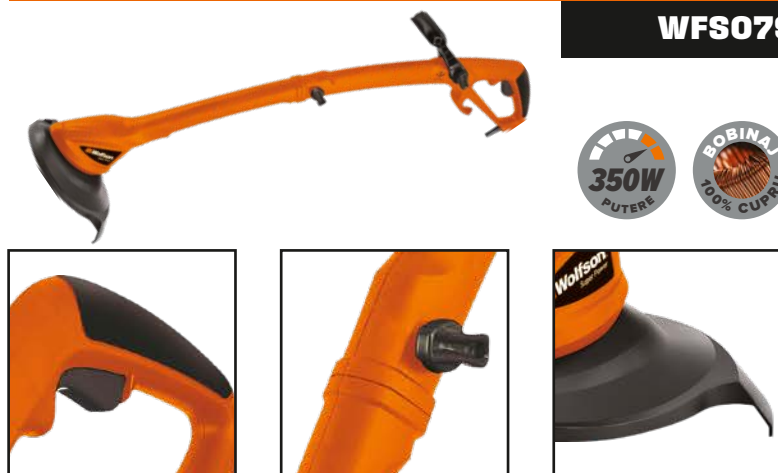

**SPECIFICAȚII TEHNICE**

Tip motor:	electric
Putere:	350W
Viteză de rotație:	10000rpm
Dimensiune tăiere:	250mm
Diametru fir:	1.2mm
Lungime fir:	6m
Tijă reglabilă	
Mâner reglabil	
Bobinaj din cupru	



**PERFORMANȚĂ  
ȘI DURABILITATE**

**PRODUSE COMPLETE**

**MAȘINI DE TUNS IARBA**



## **WOLFSON - ROBOT DE TUNS IARBA 28V**

**WFS1828R**



### **SPECIFICAȚII TEHNICE**

Tensiune baterie:	28V Lithium
Capacitate baterie:	2Ah
Tip motor:	fără perii
Viteză lame:	2900/min
Tip tăiere:	3 lame (mulching)
Lățime de tăiere:	18 cm
Suprafața de lucru:	până la 600m <sup>2</sup>
Unghi maxim de înclinație:	20°
Viteză maximă de deplasare:	0.4m/s
Lungime cablu perimetral:	100m
Număr țaruși:	150 buc
Nivel de zgomot:	60dB(A)



**MAȘINĂ DE TUNS GAZON 41CM CU AUTOPROPULSIE**

**WFS4100**



**SPECIFICAȚII TEHNICE**

Tip combustibil:	benzină
Pornire:	manual
Putere:	4.5 CP
Capacitate cilindrică:	132 cc
Lățime tăiere:	41 cm
Trepte reglare înălțime:	7
Reglare înălțime:	centralizată
Înălțime minimă tăiere:	25 mm
Înălțime maximă tăiere:	75 mm
Volum coș colector:	45 L
Dimensiuni roți față (cu rulment):	7"
Dimensiuni roți spate (cu rulment):	8"
Sac colectare spate	

**MAȘINĂ DE TUNS GAZON 46CM CU AUTOPROPULSIE**

**WFS4600**



**SPECIFICAȚII TEHNICE**

Tip combustibil:	benzină
Pornire:	manual
Putere:	4 CP
Capacitate cilindrică:	150 cc
Lățime tăiere:	46 cm
Trepte reglare înălțime:	7, centralizată
Înălțime min./max. tăiere:	25mm/75mm
Volum coș colector:	61 L
Dimensiuni roți față (cu rulment):	7"
Dimensiuni roți spate (cu rulment):	10"
Mufă pentru spălare	
Evacuare laterală	
Evacuare prin spate sau mulcing	
Sac colectare spate	

**MAȘINĂ DE TUNS GAZON 51CM CU AUTOPROPULSIE**

**WFS5100**



**SPECIFICAȚII TEHNICE**

Tip combustibil:	benzină
Pornire:	manual
Putere:	4 CP
Capacitate cilindrică:	173 cc
Lățime tăiere:	51 cm
Trepte reglare înălțime:	7, centralizată
Înălțime min./max. tăiere:	25mm/75mm
Voluim coș colector:	65L
Dimensiuni roți față (cu rulment):	8"
Dimensiuni roți spate (cu rulment):	10"
Mufă pentru spălare	
Evacuare laterală	
Evacuare prin spate sau mulcing	
Sac colector spate	

**TRACTORAȘ TUNS GAZON**

**WFS180SL**



**SPECIFICAȚII TEHNICE**

Putere:	16CP
Lățime tăiere:	108 cm
Înălțimea de tăiere:	pe 7 nivele, 30-90mm
Roțile din față:	15 x 6.00-6
Roțile din spate:	18 x 8.50-8
LWA:	100 dB(A)
Viteză de rotație:	2800 rpm/min
Greutate:	170kg

**WOLFSON - MOTOBURGHIU STB-520**

**(NU INCLUDE BURGHIE)**

**WFS0125**



**SPECIFICAȚII TEHNICE**

Putere:	2.5 CP
Tip motor:	2 timpi
Capacitate cilindrică:	52 cc
Combustibil:	amestec benzină și ulei 25:1
Capacitate rezervor:	1.2 L
Diametru găurire:	60-300mm
Greutate:	9.5kg

**MOTOBURGHIU FOREZĂ DE PĂMÂNT 52CC WOLFSON**

**WFS0025**



**SPECIFICAȚII TEHNICE**

Putere:	2.5 CP
Tip motor:	2 timpi
Capacitate cilindrică:	52 cc
Combustibil:	amestec benzină și ulei 25:1
Capacitate rezervor:	1.2 L
Diametru găurire:	60-300mm
Greutate:	9.5kg
3 burghie incluse:	100mm, 200mm și 300mm



**WOLFSON - MOTOBURGHIU STB-630**

**3 BURGHIE  
(100MM, 150MM, 200MM)**

**WFS0225**



**SPECIFICAȚII TEHNICE**

Putere:	3 CP
Tip motor:	2 timpi
Capacitate cilindrică:	63 cc
Combustibil:	amestec benzină și ulei 25:1
Capacitate rezervor:	1.2 L
Diametru găurire:	60-300mm
Greutate:	9.5kg
3 burghie incluse:	100mm, 200mm și 300mm

**WOLFSON - SUFLANTĂ ȘI ASPIRATOR DE FRUNZE**

**WFS0254B**



**SPECIFICAȚII TEHNICE**

Putere:	1 CP
Tip motor:	2 timpi
Capacitate cilindrică:	25.4 cm <sup>3</sup>
Combustibil:	amestec benzină și ulei 25:1
Capacitate rezervor:	0.45 L
Funcții:	Suflantă și aspirare
Accesorii:	Sac colector

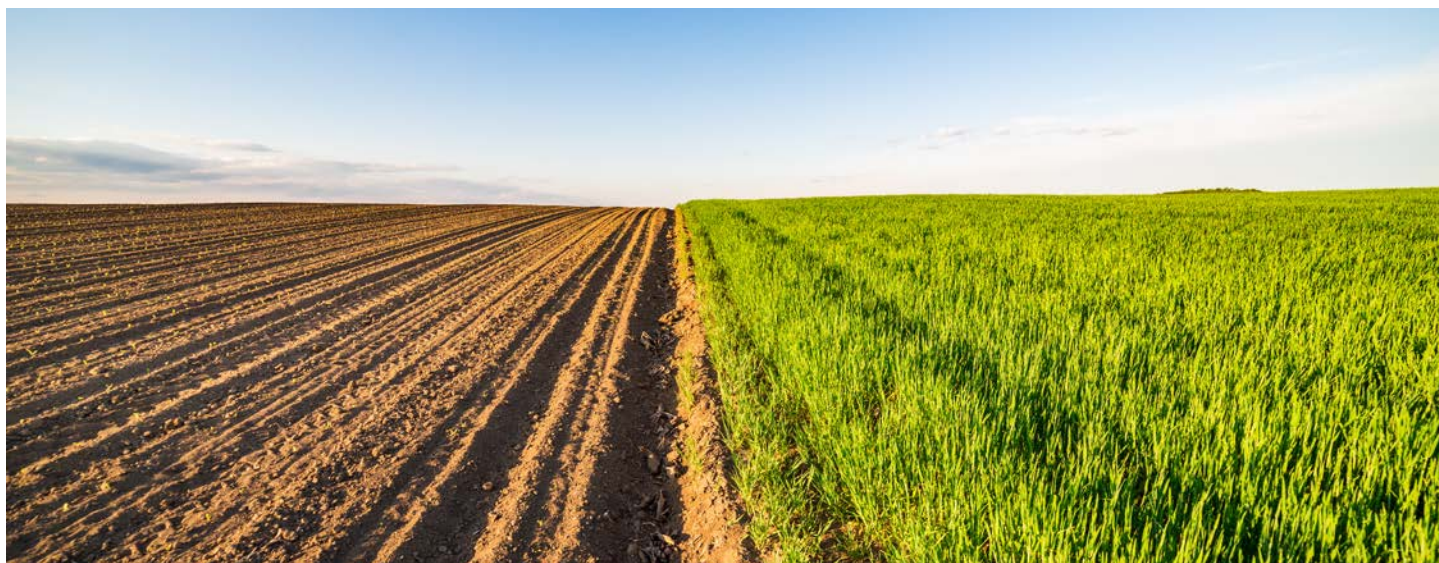

**WOLFSON - MINISĂPĂTOARE 150CC 4CP 600MM**

**WFS4000**



**SPECIFICAȚII TEHNICE**

Tip combustibil:	Benzină
Putere:	4CP
Lățime de lucru:	60cm
Adâncime de lucru:	25cm
Număr cuțite:	16
Transmisie:	Pinioane
Ghidon ajustabil:	înălțime, lateral
Pornire:	manual

**MOTOSĂPĂTOARE WOLFSON IMPERIO CU ROTI DE TRANSPORT**

**WFS7000**



**SPECIFICAȚII TEHNICE**

Capacitate cilindrică:	212 cc
Tip combustibil:	Benzina
Putere:	7CP
Lățime de lucru:	55-80cm
Adâncime de lucru:	10-36cm
Număr cuțite:	24
Accesorii:	roti de transport 4.00X8
Transmisie:	curea
Număr viteze:	2 față, 1 spate
Ghidon ajustabil:	înălțime, lateral
Pornire:	manuală

**MOTOSAPĂ WOLFSON IMPERIO CU ACCESORII PLUG, RARIȚĂ ȘI ROȚI DE TRANSPORT**

**WFS7000ACC**



**SPECIFICAȚII TEHNICE**

Capacitate cilindrică:	212 cc
Tip combustibil:	Benzina
Putere:	7CP
Lățime de lucru:	55-80cm
Adâncime de lucru:	10-36cm
Număr cuțite:	24
Accesorii:	roți de transport 4.00X8
Transmisie:	curea
Număr viteze:	2 față, 1 spate
Ghidon ajustabil:	înălțime, lateral
Pornire:	manuală

**MOTOCULTOR WOLFSON IMPERIO CU ACCESORII**

**PLUG, RARIȚĂ ȘI ROȚI DE TRANSPORT**

**WFS8000ACC**



**SPECIFICAȚII TEHNICE**

Capacitate cilindrică:	212 cc
Tip combustibil:	Benzina
Putere:	8CP
Lățime de lucru:	65-90cm
Adâncime de lucru:	10-36cm
Număr cuțite:	24
Accesorii:	roți de transport 4.00X8, plug și rariță
Transmisie:	pinioane în baie de ulei
Număr viteze:	2 față, 1 spate
Ghidon ajustabil:	înălțime, lateral
Pornire:	manuală



**MOTOCULTOR WOLFSON IMPERIO CU CU FAR ȘI ACCESORII**

**PLUG, RARIȚĂ, PRĂȘITOARE, ROȚI METALICE ȘI ROȚI DE TRANSPORT**

**WFS8001ACC**



**SPECIFICAȚII TEHNICE**

Capacitate cilindrică:	212 cc
Tip combustibil:	Benzina
Putere:	8CP
Lățime de lucru:	65-90cm
Adâncime de lucru:	10-36cm
Număr cuțite:	24
Accesorii:	roți de transport 5.00X8, roți metalice, plug, rariță și prășitoare
Transmisie:	pinioane în baie de ulei
Număr viteze:	2 față, 1 spate
Ghidon ajustabil:	înălțime, lateral
Pornire:	manuală

**WOLFSON - PLUG MOTOCULTOR ȘI MOTOSAPĂ**

**WFS7000.1**



**SPECIFICAȚII TEHNICE**

Plug de arat motocultor și motosapă Wolfson  
Compatibil cu toate modelele Wolfson

**WOLFSON - RARIȚĂ MOTOCULTOR ȘI MOTOSAPĂ**

**WFS7000.2**



**SPECIFICAȚII TEHNICE**

Rariță reglabilă  
Compatibilă cu toate modelele Wolfson

**WOLFSON - MANICOȚI MOTOCULTOR ȘI MOTOSAPĂ**

**WFS7000.3**

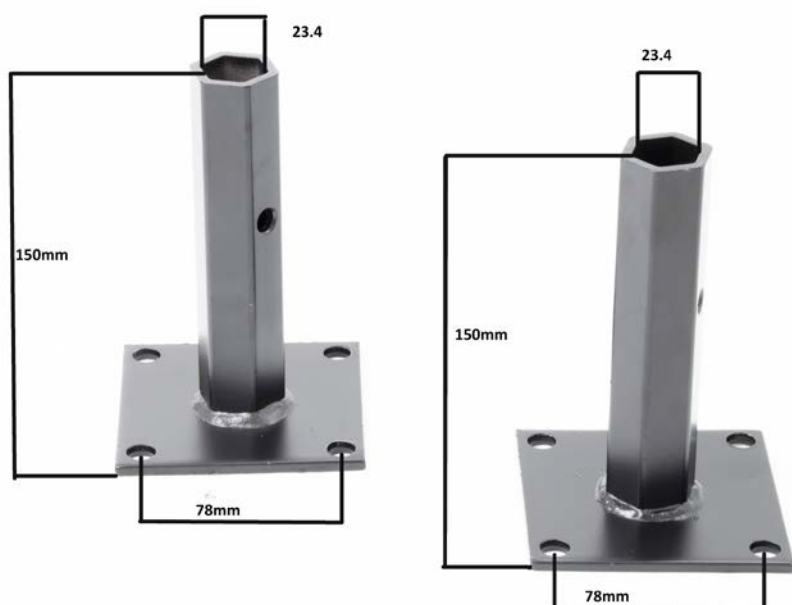

**SPECIFICAȚII TEHNICE**

Diametru gaură:	23.4 mm
Înălțime manicoț:	150 mm
Distanța între găuri:	78 mm
Manicoți motocultor și motosapă Wolfson	
Compatibili cu toate modelele Wolfson	

**WOLFSON – ROȚI METALICE 4.00X8 MOTOCULTOR ȘI MOTOSAPĂ**

**WFS7000.4**



**SPECIFICAȚII TEHNICE**

Roți metalice 4.00x8 motocultor și motosapă Wolfson  
Compatibile cu toate modelele Wolfson

**WOLFSON - PRĂȘITOARE MOTOCULTOR ȘI MOTOSAPĂ**

**WFS7000.5**



**SPECIFICAȚII TEHNICE**

Prășiitoare motocultor și motosapă  
Compatibilă cu toate modelele Wolfson



**MOTOR BENZINĂ UNIVERSAL WOLFSON® GTX-200, 7CP, 4 TIMPI OHV (170F)**

**MOTOSAPĂ, MOTOCULTOR,  
MOTOPOMPĂ, GENERATOR,  
AX CILINDRIC DIAMETRU 20MM CU PANĂ,  
FULIE DUBLĂ INCLUSĂ**

**WFS0026**

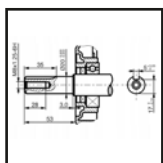

**SPECIFICAȚII TEHNICE**

Tip motor:	Monocilindru, 4-timpi, răcire cu aer, OHV
Putere maximă:	7 CP
Capacitate cilindrică:	212 cc
Capacitate rezervor:	3.6 L
Combustibil:	benzină
Capacitate rezervor ulei:	0.6 L
Ulei:	SAE 10W-30, 15W-40
Sistem de pornire:	la sfoară
Greutate:	17 kg
Tip arbore:	cilindric cu pană
Diametru ax:	20mm
Lungime ax:	50mm

**MOTOR UZ GENERAL 15CP CU FULIE DUBLĂ**

**WFS0027**



**SPECIFICAȚII TEHNICE**

Tip motor:	monocilindru, 4-timpi, răcire cu aer, OHV
Putere maximă:	15 CP
Capacitate cilindrică:	420 cc
Capacitate rezervor:	6.5 L
Combustibil:	benzină
Capacitate rezervor ulei:	1.1 L
Ulei:	SAE 10W-30, 15W-40
Sistem de pornire:	la sfoară
Greutate:	35 kg
Tip arbore:	cilindric cu pană
Diametru ax:	25mm
Lungime ax:	50mm



## GENERATOR DE CURENT WOLFSON<sup>®</sup> GT-3500A

**2600W, 7.5CP, STABILIZATOR  
TENSIUNE AVR, MONOFAZAT,  
AUTONOMIE 12 ORE**

**WFS0029**



### SPECIFICAȚII TEHNICE

Putere maximă:	2600 W
Putere continuă:	2400 W
Tip motor:	4 timpi
Tip ulei:	15W40/<0 oC: 5W30
Putere motor:	7 CP
Pornire:	manuală cu demaror
Capacitate cilindrică:	212cc
Prize ieșire:	2*VDE 230V
Tensiune normală:	230 V
Frecvență:	50 Hz
Capacitate rezervor:	15L
Capacitate baie ulei:	0.6l
Combustibil:	benzină
Greutate:	42 kg

**GENERATOR DE CURENT CU INVERTOR WOLFSON**

**2000W, 3.5CP**

**WFS2000I**



**SPECIFICAȚII TEHNICE**

Putere maximă:	2200 W
Putere continuă:	1800 W
Tip motor:	4 timpi
Tip ulei:	10W30
Putere motor:	3.5 CP
Pornire:	manuală cu demaror
Capacitate cilindrică:	79cc
Prize ieșire:	2*VDE 230V
Tensiune normală:	230 V
Frecvență:	50 Hz
Capacitate rezervor:	4L
Capacitate baie ulei:	0.35l
Combustibil:	benzină
Greutate:	21 kg

**GENERATOR DE CURENT WOLFSON® D7700-E**

**6500W, 11CP, STABILIZATOR  
TENSIUNE AVR, MONOFAZAT**

**WFS7700D-E**



**SPECIFICAȚII TEHNICE**

Putere maximă:	6500 W
Putere continuă:	6000 W
Tip motor:	4 timpi diesel
Tip ulei:	10W30
Putere motor:	11 CP
Pornire:	electrică/manuală cu demaror
Capacitate cilindrică:	474cc
Prize ieșire:	1*VDE 230V, 1xpower plug
Tensiune normală:	230 V
Frecvență:	50 Hz
Capacitate rezervor:	18L
Capacitate baie ulei:	0.6l
Combustibil:	motorină
Greutate:	43 kg



**GENERATOR DE CURENT CU APARAT DE SUDURA WOLFSON<sup>®</sup> D7700-E**

**6500W, 11CP, STABILIZATOR  
TENSIUNE AVR, MONOFAZAT**

**WFS5G19WD**



**SPECIFICAȚII TEHNICE**

**Aparat sudură**

Tip sudură:	MMA
Curent de sudură max.:	190A
Tensiune:	26V
Putere:	5kW

**Generator curent**

Putere continuă:	5000 W
Tip motor:	4 timpi diesel
Tip ulei:	10W30
Putere motor:	10 CP
Pornire:	electrică/manuală cu demaror
Capacitate cilindrică:	418cc
Prize ieșire:	1*VDE 230V, 1x power plug
Tensiune normală:	230 V
Frecvență:	50 Hz
Capacitate rezervor:	2.5L
Capacitate baie ulei:	1.65L
Combustibil:	motorină
Greutate:	43 kg

**GENERATOR DE CURENT CU AUTOMATIZARE WOLFSON<sup>®</sup> 012SS PROFESIONAL**

**WFS012SS**



**SPECIFICAȚII TEHNICE**

Putere maximă:	10.5 kW
Putere continuă:	9.5 kW
Pornire:	automatizare/electrică 12V
Capacitate cilindrică:	954cc
Tensiune normală:	230 V
Frecvență:	50 Hz
Capacitate rezervor:	30L
Capacitate baie ulei:	3.15L
Tip ulei:	15W40
Combustibil:	motorină



**GENERATOR WOLFSON® IMPERIO 3000**

**WFS4650**



**SPECIFICAȚII TEHNICE**

Putere maximă:	3000 W
Putere continuă:	2800 W
Tip curent:	monofazat
Tip motor:	4 timpi
Putere motor:	7 CP
Capacitate cilindrică:	212cc
Pornire:	electrică și manuală
Tensiune normală:	230 V
Frecvență:	50 Hz
Capacitate rezervor:	15L
Capacitate baie ulei:	0.6l
Combustibil:	benzină
Greutate:	42 kg

**GENERATOR WOLFSON® IMPERIO 6600**

**WFS9250**



**SPECIFICAȚII TEHNICE**

Putere maximă:	6500 W
Putere continuă:	6000 W
Tip curent:	monofazat
Tip motor:	4 timpi
Putere motor:	15 CP
Capacitate cilindrică:	420cc
Pornire:	electrică și manuală
Tensiune normală:	230 V
Frecvență:	50 Hz
Capacitate rezervor:	25L
Capacitate baie ulei:	1l
Combustibil:	benzină
Greutate:	90 kg

**GENERATOR WOLFSON<sup>®</sup> IMPERIO 8300**

COMPATIBIL CU AUTOMATIZARE ADG11050

**WFS11050**



**SPECIFICAȚII TEHNICE**

Putere maximă:	7900 W
Putere continuă:	7500 W
Tip curent:	monofazat
Tip motor:	4 timpi
Putere motor:	17.5 CP
Capacitate cilindrică:	457cc
Pornire:	electrică și manuală
Tensiune normală/frecvență:	230 V/ 50 Hz
Nivel zgomot:	77 dB
Capacitate rezervor:	25L
Capacitate baie ulei:	1L
Combustibil:	benzină
Greutate:	94 kg

**AUTOMATIZARE WOLFSON<sup>®</sup> IMPERIO**

COMPATIBIL CU WFS11050

**ADG11050**



**SPECIFICAȚII TEHNICE**

Putere:	13.2 Kw
In A:	60/30
Tensiune:	220/240
Dimensiuni (mm):	320x250x140
Greutate:	6kg

**MOTOPOMPĂ APĂ WOLFSON® WT-20, 2 ȚOLI**

**WFS0024**



**SPECIFICAȚII TEHNICE**

Putere:	6.5 CP
Tip motor:	4 timpi
Capacitate cilindrică:	196cc
Debit max:	27000 L/h
Înălțime max. de livrare:	26m
Adâncime max. absorbție:	7m
Autonomie max:	4h
Racordare:	2"
Capacitate rezervor:	3.6L
Greutate:	26kg
Accesorii incluse:	2buc racord 2"; 3buc coliere 2"; 1buc sorb cu sită; 1buc cheie bujie

**WOLFSON - MOTOPOMPĂ DE APĂ WT-30 - BENZINĂ**

**WFS0023**



**SPECIFICAȚII TEHNICE**

Putere:	6.5 CP
Tip motor:	4 timpi
Capacitate cilindrică:	196cc
Debit max:	60000 L/h
Înălțime max. de livrare:	30m
Adâncime max. absorbție:	8m
Racordare:	3"
Capacitate rezervor:	3.6L
Greutate:	26 kg

**FURTUN POMPIERI 2" CU MUFE CUPLARE WOLFSON**

**WFS0018**



**SPECIFICAȚII TEHNICE**

Tip produs:	furtun
Tip:	PSI
Utilizare:	supraterană
Material:	cauciuc + textil
Dimensiune racord:	2 inci (Țoli)
Diametru:	50mm
Presiune maximă:	8 bar
Culoare:	alb/gri
Lungime:	20m



**MOARĂ ELECTRICĂ WOLFSON® MCR-1 (2 IN 1), CUVĂ MARE**

**WFS0001**



**SPECIFICAȚII TEHNICE**

Utilizat pentru:	cereale, furaje
Tip alimentare:	Electric
Putere motor:	2.7 kW
Tensiune alimentare:	230 V
Viteză maximă:	3000 rpm
Capacitate mărunțire:	320 kg/h
Capacitate coș:	20 Kg
Dimensiuni coș:	320x300mm
Număr ciocănele:	20
Număr site:	4
Diametru orificii sită:	2, 3, 4, 5 mm

**MOARĂ ELECTRICĂ CU SUPORT METALIC WOLFSON® MCR-1S (2 IN 1), CUVĂ MARE**

**WFS0002**



**SPECIFICAȚII TEHNICE**

Utilizat pentru:	cereale, furaje
Tip alimentare:	electric
Putere motor:	2.7 kW
Tensiune alimentare:	230 V
Viteză maximă:	3000 rpm
Capacitate mărunțire:	320 kg/h
Capacitate coș:	20 Kg
Dimensiuni coș:	320x300mm
Număr ciocănele:	20
Număr site:	4
Diametru orificii sită:	2, 3, 4, 5 mm
Accesorii:	suport/cadru metalic, 4 site, pensulă, șurubelniță, sac colector furaje din material textil, 10 saci de rafie

**WOLFSON MOARA INDUSTRIALĂ**

**2.2 KW**

**WFS0005**



**SPECIFICAȚII TEHNICE**

Tip motor:	electric
Putere motor:	2.2 kW
	Voltaj: 220 V
Viteză motor:	2800 rpm
Sistem măcinare:	disc
Viteză sistem măcinare:	5500 rpm
Cuve:	2 - superioară (cuva 1) și laterală (cuva 2)
Alimentare Productivitate:	250 kg/h
Număr site:	12
Site:	0.2/ 0.4/ 0.6/ 0.8/ 1.0/ 2.0/ 3.0/ 4.0/ 6.0/ 8.0/ 10.0/ 12.0mm
Greutate brută:	52 kg





**POMPĂ DE APĂ CU VIBRAȚII VMP60**

**280W**

**WFS0019**



**SPECIFICAȚII TEHNICE**

Tip motor:	electric
Putere motor:	280 W
Tensiune alimentare:	220 V
Diametru racord refulare:	0.75 inch
Debit maxim:	18 l/min
Înălțime de refulare:	70m
Adâncime de absorbție:	6m
Presiune maximă:	8 bar

**POMPĂ DE APĂ CU TURBINĂ SKM150**

**1100W**

**WFS0020**



**SPECIFICAȚII TEHNICE**

Tip motor:	electric
Putere:	1100 W
Putere motor:	1100 W
Viteză maximă:	2860 rpm
Diametru racord refulare:	1 inch
Debit maxim:	3300 l/h
Înălțime de refulare:	99m
Presiune maximă:	6 bar

**POMPĂ SUBMERSIBILĂ APĂ MURDARĂ, CU FLOTOR WOLFSON<sup>®</sup> TP-3100**

**WFS0012**



**SPECIFICAȚII TEHNICE**

Putere:	1300 W
Adâncime max.:	6m
Lungime cablu:	15m
Debit max.:	10000 l/h
Carcasă:	fontă
Motor:	electric asincron
Protecție suprasarcină:	da
Diametru refulare:	2"

**POMPĂ SUBMERSIBILĂ APĂ MURDARĂ, CU TOCĂTOR ȘI FLOTOR WOLFSON<sup>®</sup> TP-3300T**

**WFS0014**



**SPECIFICAȚII TEHNICE**

Putere:	1300 W
Adâncime max.:	6m
Debit max.:	10000 l/h
Carcasă:	fontă
Motor:	electric asincron
Protecție suprasarcină:	da
Diametru refulare:	2"
	Cu tocător

**WOLFSON - POMPA SUBMERSIBILĂ - APĂ MURDARĂ - CU TOCATOR EXT -WQW-1500D-F PRO**

**WFS0013**



**SPECIFICAȚII TEHNICE**

Putere:	1500 W
rotații:	2860 rpm
Debit max.:	330L/min
Înălțime max. de livrare:	11m
Racordare:	2"
Cu flotor	
Alimentare:	220 V/ 50 Hz
Cablu alimentare:	8m
Temperatură max.:	35 grade C
Greutate:	20kg

**POMPĂ SUBMERSIBILĂ APĂ CURATĂ, MULTIETAJATĂ WOLFSON® PM-1500-8**

**WFS0021**



**SPECIFICAȚII TEHNICE**

Putere:	1500 W
Înălțime max:	120m
Adâncime max:	30m
Lungime cablu:	25m
Debit max:	5200 l/h
Carcasă:	inox
Motor:	electric asincron
Protecție suprasarcină:	da
Diametru refulare:	1"



**POMPĂ SUBMERSIBILĂ APĂ CURATĂ WOLFSON® PS-1300**

**WFS0022**



**SPECIFICAȚII TEHNICE**

Putere:	1300 W
Înălțime max:	80m
Adâncime max:	20m
Lungime cablu:	15m
Debit max:	3200 l/h
Carcasă:	inox
Motor:	electric asincron
Protecție suprasarcină:	da
Diametru refulare:	1"
Greutate:	9kg



**WOLFSON - POMPĂ DE SUPRAFAȚĂ, CENTRIFUGALĂ - APĂ CURATĂ - QB-60**

**WFS0030**



**SPECIFICAȚII TEHNICE**

Putere:	370 W
Rotații:	2860 rpm
Debit max.:	2100 L/h
Înălțime max. de livrare:	35m
Adâncime max. absorbție:	7m
Racordare:	1" x 1"
Clasă protecție:	IP 44
Izolație:	clasa F

**WOLFSON - POMPĂ DE SUPRAFAȚĂ, CENTRIFUGALĂ - APĂ CURATĂ - CPM-158**

**WFS0031**



**SPECIFICAȚII TEHNICE**

Putere:	750 W
Rotații:	2860 rpm
Debit max.:	6600 L/h
Înălțime max. de livrare:	32m
Adâncime max. absorbție:	8m
Alimentare:	220 V/ 50 Hz
Racordare:	1" x 1"
Clasă protecție:	IP 44
Izolație:	clasa F
Presiune max.:	3.2 bar
Greutate:	11 kg



**WOLFSON - POMPĂ DE SUPRAFAȚĂ, CENTRIFUGALĂ - APĂ CURATĂ - JET-100L**

**WFS0032**



**SPECIFICAȚII TEHNICE**

Putere:	800 W
rotații:	2860 rpm
Debit max.:	3200 L/h
Înălțime maximă de livrare:	40 m
Adâncime max. absorbție:	8 m
Racordare:	1" x 1"
Dimensiune max. impurități:	3 mm
Temperatură max.:	35 grade C
Greutate:	12kg

**WOLFSON - POMPĂ DE SUPRAFAȚĂ, CENTRIFUGALĂ - APĂ CURATĂ - JET-100E**

**CU EJECTOR**

**WFS0033**



**SPECIFICAȚII TEHNICE**

Putere:	800 W
Debit max.:	3200 L/h
Înălțime max. de livrare:	40 m
Adâncime max. absorbție:	25 m
Racordare intrare/ieșire:	1.1/4" x 1"
Dimensiune max. impurități:	3mm
Temperatură max.:	35 grade C
Alimentare:	220V/50Hz
Greutate:	14 kg

**WOLFSON - HIDROFOR CAP FONTĂ - 24L - 800-3C**

**WFS0034**



**SPECIFICAȚII TEHNICE**

Putere:	800 W
Debit max.:	3200 L/h
Înălțime max. de livrare:	40 m
Adâncime max. absorbție:	8 m
Racordare:	1"
Temperatură max.:	35 grade C
Alimentare:	220 V/ 50 Hz
Greutate:	20 kg

**WOLFSON - HIDROFOR CAP INOX - 24L - 800-3C**

**WFS0035**



**SPECIFICAȚII TEHNICE**

Putere:	800 W
Debit max.:	3200 L/h
Înălțime max. de livrare:	40 m
Adâncime max. absorbție:	8 m
Racordare:	1"
Temperatură max.:	35 grade C
Alimentare:	220 V/ 50 Hz
Greutate:	14 kg

**WOLFSON - HIDROFOR CAP POMPĂ FONTĂ - CU EJECTOR - 24L - 800-3D - 800W**

**WFS0036**



**SPECIFICAȚII TEHNICE**

Putere:	800 W
Debit max.:	3200 L/h
Înălțime max. de livrare:	40 m
Adâncime max. absorbție:	25 m
Racordare intrare/ieșire:	1.1/4" x1"
Temperatură max.:	35 grade C
Alimentare:	220 V/ 50 Hz
Greutate:	22 kg

**WOLFSON - POMPĂ SUBMERSIBILĂ - APĂ CURATĂ - QDX-16-F**

**WFS0037**



**SPECIFICAȚII TEHNICE**

Putere:	370 W
rotații:	2860 rpm
Debit max.:	3000L/h
Adâncime max. absorbție:	16 m
Racordare:	1"
Cu flotor	
Alimentare:	220 V/ 50 Hz

**WOLFSON - POMPĂ SUBMERSIBILĂ - APĂ CURATĂ - QDX-20-F**

**WFS0038**



**SPECIFICAȚII TEHNICE**

Putere:	550 W
rotații:	2860 rpm
Debit max.:	3000 L/h
Adâncime max. absorbție:	20 m
Racordare:	1"
Cu flotor	
Alimentare:	220 V/ 50 Hz



**WOLFSON - POMPĂ SUBMERSIBILĂ - APĂ CURATĂ - QDX-32-F**

**WFS0039**



**SPECIFICAȚII TEHNICE**

Putere:	750 W
Rotatii:	2860 rpm
Debit max.:	3000 L/h
Adâncime max. absorbție:	32 m
Racordare:	1"
Cu flotor	
Alimentare:	220 V/ 50 Hz

**PULVERIZATOR 12L CU BATERIE WOLFSON**

**WFS072**



**SPECIFICAȚII TEHNICE**

Baterie:	12V , 8Ah
Capacitate rezervor:	12 L
Lance telescopică	
Presiune de lucru:	2-4 BAR

**PERFORMANȚĂ  
ȘI DURABILITATE**

**PRODUSE COMPLETE**

**SCULE DE MÂNĂ  
PENTRU GRĂDINĂ**



**TOPORIȘĂ 600G 360MM MÂNER DIN FIBRĂ DE STICLĂ WOLFSON**

**WFS6036FG**



**SPECIFICAȚII TEHNICE**

Greutate:	600 gr
Lungime mâner:	360 mm
Mâner:	fibră de sticlă

**TOPORIȘCĂ 600G 360MM MÂNER DIN LEMN WOLFSON**

**WFS6036WD**



**SPECIFICAȚII TEHNICE**

Greutate:	600 gr
Lungime mâner:	360 mm
Mâner:	lemn

**TOPORIȘCĂ 800G 380MM MÂNER DIN FIBRĂ DE STICLĂ WOLFSON**

**WFS8038FG**



**SPECIFICAȚII TEHNICE**

Greutate:	800 gr
Lungime mâner:	380 mm
Mâner:	fibră de sticlă

**TOPORIȘCĂ 800G 380MM MÂNER DIN LEMN WOLFSON**

**WFS8038WD**



**SPECIFICAȚII TEHNICE**

Greutate:	800 gr
Lungime mâner:	380 mm
Mâner:	lemn



**PERFORMANȚĂ  
ȘI DURABILITATE**

**PRODUSE COMPLETE**

**SCULE DE MÂNĂ  
PENTRU GRĂDINĂ**

**TOPOR 1250G 800MM MÂNER DIN FIBRĂ DE STICLĂ WOLFSON**

**WFS1280FG**



**SPECIFICAȚII TEHNICE**

Greutate:	1250 gr
Lungime mâner:	800 mm
Mâner:	fibră de sticlă

**TOPOR PENTRU DESPICAT 2700G 900MM MÂNER DIN FIBRĂ DE STICLĂ WOLFSON**

**WFS2790FG**



**SPECIFICAȚII TEHNICE**

Greutate:	2700 gr
Lungime mâner:	900 mm
Mâner:	fibră de sticlă

**TOPOR PENTRU DESPICAT MODEL JAPONEZ 2000G 800MM MÂNER DIN LEMN WOLFSON**

**WFS2080WD**



**SPECIFICAȚII TEHNICE**

Greutate:	2000 gr
Lungime mâner:	800 mm
Mâner:	lemn

**FOARFECĂ DE VIE 8" MÂNERE DIN CAUCIUC WOLFSON**

**WFS2032S**



**SPECIFICAȚII TEHNICE**

Foarfecă pentru vie 8"  
Mânere din cauciuc  
Din oțel prelucrat la cald  
Lame ascuțite întărite

**FOARFECĂ DE VIE 8.5" MÂNERE DIN PLASTIC WOLFSON**

**WFS2159P**



**SPECIFICAȚII TEHNICE**

Foarfecă pentru vie 8,5"  
Mânere din plastic  
Din oțel prelucrat la cald  
Lame ascuțite întărite

**FOARFECĂ DE VIE 8.5" MÂNERE DIN TEFLON WOLFSON**

**WFS2159C**



**SPECIFICAȚII TEHNICE**

Lamă din oțel  
Mâner din teflon  
Amortizor din cauciuc

**FOARFECĂ PENTRU CRENGI 215MM MÂNERE DIN TEFLON WOLFSON**

**WFS2159TC**



**SPECIFICAȚII TEHNICE**

Foarfecă pentru crengi  
Mânere din teflon  
Amortizor din cauciuc

**FOARFECĂ PENTRU CRENGI 30MM LUNGIME 770MM WOLFSON**

**WFS3077N**



**SPECIFICAȚII TEHNICE**

Foarfecă pentru crengi  
Lungime: 770mm  
Foarfecă: 30 mm

**FOARFECĂ PENTRU CRENGI 30MM CU MÂNERE TELESCOPICE LUNGIME 715-925MM WOLFSON**

**WFS3092T**



**SPECIFICAȚII TEHNICE**

Foarfecă pentru crengi  
Mânere telescopice: 715 - 925 mm  
Foarfecă: 30 mm



**FOARFECĂ PENTRU ALTOIT, 4 ACCESORII WOLFSON**

**WFS2600A3**



**SPECIFICAȚII TEHNICE**

Foarfecă pentru altoit  
4 accesorii: 3 lame interschimbabile,  
1 opritor

**FOARFECĂ PENTRU GARD VIU 620MM WOLFSON**

**WFS0620N**



**SPECIFICAȚII TEHNICE**

Foarfecă pentru gard viu: 620mm

**FOARFECĂ PENTRU GARD VIU CU MÂNERE TELESCOPICE 675-865MM WOLFSON**

**WFS0620T**



**SPECIFICAȚII TEHNICE**

Mânere telescopice: 675 - 865 mm

**FIERĂSTRĂU ȘI FOARFECĂ PENTRU CRENGI CU MÂNER TELESCOPIC 1140-2250MM WOLFSON**

**WFS1422T**



**SPECIFICAȚII TEHNICE**

Mâner telescopic: 1140 - 2250 mm

**FIERĂSTRĂU PENTRU CRENGI CU TEACĂ 300MM WOLFSON**

**WFS0300SC**



**SPECIFICAȚII TEHNICE**

Fierăstrău pentru crengi  
Lungime: 770 mm

**FIERĂSTRĂU PENTRU CRENGI PLIABIL 180MM WOLFSON**

**WFS0180F**



**SPECIFICAȚII TEHNICE**

Dinți întăriți HRC 55-60  
Dinți în 3 muchii  
Pentru lemn și pvc  
Mâner ergonomic antiderapant cu inserții de cauciuc.

**FIERĂSTRĂU PENDULAR**

**WFS052**

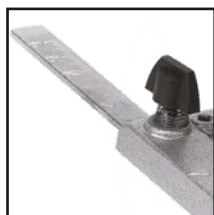

**SPECIFICAȚII TEHNICE**

Putere: 850 W  
Viteză de rotație: 800-3100 rpm  
Adâncime de tăiere: Lemn - 100 mm  
Metal - 10 mm

Ghidaj luminos  
Variator de turație  
Protecție din plastic pentru talpă

**FIERĂSTRĂU SABIE**

**WFS050**



**SPECIFICAȚII TEHNICE**

Putere: 950 W  
Viteză de rotație: 0-2800 rpm  
Adâncime de tăiere: Lemn - 150mm  
Metal - 8mm  
Aluminiu - 12mm

Accesorii: 2 lame (lemn și metal)  
Prindere rapidă  
100% bobinaj cupru



**FIERASTRAU CIRCULAR STATIONAR WOLFSON**

**WFS074**



**SPECIFICAȚII TEHNICE**

Putere:	2000W
Tensiune:	220V
Ghidaj luminos	
Caracteristici tăiere:	0°x90° 65x340mm 0°x45° 38x340mm 45°x45° 38x240mm
Viteză de rotație:	4800 rpm
Dimensiune disc tăiere:	210mm

**FIERASTRAU CIRCULAR PENTRU LEMN WOLFSON**

**WFS075**



**SPECIFICAȚII TEHNICE**

Putere:	1380W
Tensiune de alimentare:	220V/50Hz
Lamă:	185mm, 24 dinti, ax 25.4mm
Viteză de rotație:	5300 rpm
Bobinaj:	100% cupru
Unghi reglabil	
Riglă de menținere a tăieturii drepte	

## MAȘINĂ DE TENCUIT PNEUMATICĂ WOLFSON

WFS077



### SPECIFICAȚII TEHNICE

Tip:	pneumatic
Presiune de lucru:	6 Bar
Capacitate rezervor:	3.5L
Lungime totală:	63 cm
Dimensiuni găuri pulverizare:	18 mm
Distanță de pulverizare:	50-100mm

## MIXER MORTAR

WFS065

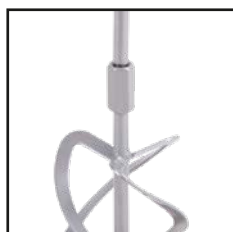

### SPECIFICAȚII TEHNICE

Tip motor:	electric
Putere:	1300W
Viteză de rotație:	0-700 rpm
Lungime tijă de mixare:	580mm
Conexiune ax:	M14

## MAȘINĂ DE TĂIAT CANELURI WOLFSON

WFS078



### SPECIFICAȚII TEHNICE

Putere:	1500W
Tensiune de alimentare:	220V/50Hz
Discuri:	125mm
Viteză de rotație:	8500rpm
Bobinaj:	100%cupru
Adâncime și latime canal reglabile	
Conținut pachet:	2x discuri 125mm

**PERFORMANȚĂ  
ȘI DURABILITATE**

**PRODUSE COMPLETE  
MAȘINI DE ÎNȘURUBAT ȘI GĂURIT  
CU ACUMULATOR**



## MAȘINĂ DE ÎNȘURUBAT CU IMPACT ȘI ACUMULATOR WOLFSON

**WFS053**



### SPECIFICAȚII TEHNICE

Tip motor:	electric de tip brushless (fără perii)
Baterie:	21V, 2Ah
Timp de încărcare:	1.5 h
Putere:	100/140/180Nm
Viteză:	0-1500/0-2200/0-2900 rpm
Conținut pachet:	2 acumulatori 2 Ah, 21V încărcător rapid 7 burghie 9 biți CR-V șuruburi diferite dimensiuni cutie de transport BMC



**MAȘINĂ DE ÎNȘURUBAT CU IMPACT ȘI ACUMULATOR WOLFSON**

**WFS054**



**SPECIFICAȚII TEHNICE**

Tip motor:	electric de tip brushless (fără perii)
Baterie:	21V, 2Ah
Timpe de încărcare:	1.5 h
Putere:	100/140/180Nm
Viteză:	0-1500/0-2200/0-2900 rpm
Conținut pachet:	2 acumulatori 2 Ah, 21V încărcător rapid 7 burghie 9 biți CR-V șuruburi diferite dimensiuni cutie de transport BMC

**MAȘINĂ DE ÎNȘURUBAT CU IMPACT 1/2" ACUMULATOR**

**WFS051**



**SPECIFICAȚII TEHNICE**

Tip motor:	electric de tip brushless (fără perii)
Baterie:	21V, 2 Ah
Timpe de încărcare:	1.5 h
Putere:	400 Nm
Viteză:	0-1750/0-2350 rpm
Conținut pachet:	2 acumulatori 21V, 2 Ah încărcător rapid 3 chei de impact (17, 19, 21mm) cutie transport BMC

**MAȘINĂ DE GĂURIT ȘI ÎNȘURUBAT 280W**

**WFS055**



**SPECIFICAȚII TEHNICE**

Putere:	280W
Viteză de rotație:	0-750rpm
Mandrină:	10mm
Trepte de putere:	8+1

**MAȘINĂ DE GĂURIT CU IMPACT 500W**

**WFS056**



**SPECIFICAȚII TEHNICE**

Tip motor:	electric
Putere:	650 W
Viteză de rotație:	0-3000 rpm
Mandrină:	13 mm
Găurire:	lemn - 25mm zidarie - 16mm fier - 13mm

**MAȘINĂ DE GĂURIT CU IMPACT 850W**

**WFS057**



**SPECIFICAȚII TEHNICE**

Tip motor:	electric 220V
Putere:	850W
Viteză de rotație:	0-3000rpm
Mandrină:	13mm
Găurire:	lemn - 25mm zidarie - 16mm fier - 13mm
Mâner soft grip	

**CIOCAN ROTOPERCUTOR 800W**

**WFS058**



**SPECIFICAȚII TEHNICE**

Putere:	800 W
Viteză de rotație:	0-1100 rpm
Rata de impact:	4000 bpm
Putere de impact:	4J
Tip mandrină:	SDS Plus, suplimentar mandrină cu prindere normală
Găurire:	lemn - 25mm zidarie - 16mm fier - 13 mm
Conținut pachet:	3x Burghie (6, 8, 10mm) Spitz Delta Cutie de transport

**CIOCAN ROTOPERCUTOR 1600W**

**WFS059**



**SPECIFICAȚII TEHNICE**

Putere:	1600 W
Viteză de rotație:	0-1100 rpm
Rată de impact:	4300 bpm
Putere de impact:	5.5J
Mandrină:	SDS Plus
Găurire:	lemn - 42mm beton - 32mm fier - 13mm
Continut pachet:	3x burghie (6, 8, 10mm) 2x dalti cutie de transport

**POLIZOR UNGHIULAR 900W, 125MM, M14**

**WFS062**



**SPECIFICAȚII TEHNICE**

Tip motor:	electric
Putere:	900W
Tensiune de alimentare:	220 V
Viteză de rotație:	0-11000rpm (variator de turație)
Ax:	M14
Dimensiune disc:	125mm

**POLIZOR UNGHIULAR 1050W, 125MM, M14**

**WFS063**



**SPECIFICAȚII TEHNICE**

Tip motor:	electric
Putere:	1050W
Viteză de rotație:	0-11000rpm (variator de turație)
Ax:	M14
Dimensiune disc:	125mm

**POLIZOR DE BANC 250W**

**WFS060**



**SPECIFICAȚII TEHNICE**

Tip motor:	electric
Putere:	250 W
Tensiune de alimentare:	220V
Viteză de rotație:	0-3000 rpm
Dimensiune piatră:	150mm/6"
Buton ON/OFF cu protecție:	DA



**RINDEA ELECTRICĂ 900W**

**WFS066**



**SPECIFICAȚII TEHNICE**

Tip motor:	electric
Putere:	800W
Tensiune de alimentare:	220 V
Viteză de rotație:	360 rpm
Dimensiuni lame:	80 mm
Conținut pachet:	sac pentru aspirare

**ȘLEFUITOR ORBITAL 240W**

**WFS064**



**SPECIFICAȚII TEHNICE**

Putere:	350 W
Tensiune de alimentare:	220 V
Viteză de rotație:	0-12000 rpm
Accesorii:	sac pentru aspirare variator de turatie mănuși de protecție M10 - mărime 8
Dimensiune disc:	125mm

**ȘLEFUITOR PEREȚI 180MM, CU ASPIRATOR**

**WFS067**



**SPECIFICAȚII TEHNICE**

Tip motor:	electric
Tensiune de alimentare:	220V/ 50 Hz
Putere:	710W
Viteză de rotație:	1200-2500 rpm
Diametru disc:	180mm
Conținut pachet:	6 discuri furtun aspirație 2 m sac colectare praf set cărbuni bandă LED

**ȘLEFUITOR PEREȚI 225MM. CU TIJĂ ȘI ASPIRATOR**

**WFS068**



**SPECIFICAȚII TEHNICE**

Putere:	750W
Tensiune de alimentare:	220V/50Hz
Diametru disc:	225mm
Conținut pachet:	6 discuri furtun aspirație 2m sac colectare set cărbuni bandă LED
Viteză de rotație:	1200-2500 rpm



**APARAT DE SUDURĂ WOLFSON® ATX-270**

**WFS0003**



**SPECIFICAȚII TEHNICE**

Ajustarea curentului de ieșire:	20 - 120 A
Ciclu de lucru:	60 %
Eficiență:	90 %
Putere absorbită:	12.5KVA
Tensiune de alimentare:	220 V
Conector rapid:	10-25
Diametru electrod:	1.6-4mm
Greutate:	3kg
Accesorii incluse:	clemă cu cablu legare pământ 1.3m, clemă cu cablu portelectrod 1.8m, perie cu ciocănel pentru zgură, mască sudură simplă, curea transport

**APARAT DE SUDURĂ WOLFSON® ATX-320**

**WFS0004**

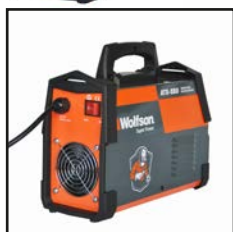

**SPECIFICAȚII TEHNICE**

Ajustarea curentului de ieșire:	20 - 140 A
Ciclu de lucru:	60 %
Eficiență:	90 %
Putere absorbită:	12.5KVA
Tensiune de alimentare:	220 V
Conector rapid:	10-25
Diametru electrod:	1.6-4mm
Greutate:	5kg
Accesorii incluse:	clemă cu cablu legare pământ 1.3m, clemă cu cablu portelectrod 1.8m, perie cu ciocănel pentru zgură, mască sudură simplă



**APARAT PENTRU SUDAT ȚEVI PPR (3 BACURI) WOLFSON**

**WFS069**



**SPECIFICAȚII TEHNICE**

Tip:	electric
Putere:	800 W
Dimensiuni sudare:	20, 25, 32, 40, 50, 63 mm
Reglaj temperatură:	0-300°C
Accesorii:	suport metalic, cutie metalică, mănuși, ruletă, cheie imbus, șurubelniță

**APARAT PENTRU SUDAT ȚEVI PPR (6 BACURI) WOLFSON**

**WFS070**



**SPECIFICAȚII TEHNICE**

Tip:	electric
Putere:	600W
Tensiune de alimentare:	220 V
Dimensiuni sudare:	20, 25, 32 mm
Reglaj temperatură:	0-300°C
Accesorii:	suport metalic, cutie metalică



**BOCANCI DE PROTECȚIE SB**

**WFS9001.SB.39**



**SPECIFICAȚII TEHNICE**

Material: PU + Piele  
Protecție vârf metalic  
Mărimi: 39-44

**BOCANCI DE PROTECȚIE S1P WOLFSON**

**WFS9002.S1P.39**



**SPECIFICAȚII TEHNICE**

Material: PU + Piele întoarsă  
Protecție vârf metalic  
Protecție metalică talpă  
Mărimi: 39-44

**GENUNCHIERE**

**WFS9003G**



**SPECIFICAȚII TEHNICE**

Material: PU + XOFORD

**VESTĂ DE LUCRU**

**WFS9004VL**



**SPECIFICAȚII TEHNICE**

Material: canvas + textil

**COMBINEZON DE LUCRU**

**WFS9005C**



**SPECIFICAȚII TEHNICE**

Material: 65% POLYSTER  
35% COTTON 260g/m2  
CANVAS

**SET COSTUM ȘI PANTALONI DE LUCRU**

**WFS9006VP**



**SPECIFICAȚII TEHNICE**

Material: 65% POLYSTER  
35% COTTON 260g/m<sup>2</sup>  
CANVAS

**SALOPETĂ DE LUCRU**

**WFS9007S**



**SPECIFICAȚII TEHNICE**

Material: 65% POLYSTER  
35% COTTON 260g/m<sup>2</sup>  
CANVAS

**PELERINĂ DE PLOAIE**

**WFS9008PP**



**SPECIFICAȚII TEHNICE**

Material:	PP
Grosime:	0.28

**HALAT DE SUDOR**

**WFS9009W**



**SPECIFICAȚII TEHNICE**

Material:	Piele
-----------	-------



**BRAND 100%  
ROMÂNESC**



**BEST CHOICE**

**Wolfson®**

**PROFESSIONAL  
TOOLS**

# PERFORMANȚĂ ȘI DURABILITATE PENTRU LUCRĂRI PROFESIONISTE

Gama completă de scule, unelte, utilaje și accesorii.

**RIVIERAWORKS.RO**

RIVIERA WORKS SRL  
Str. Tănase Banciu 12 Popesti-Leordeni,  
județ Ilfov, România

**SOLUȚII**

**CASĂ • FERMĂ • GRĂDINĂ**

**COMPLETE**